

SPECIFICATION

ITEM P/N	DB54A-SERIES-PF	TEST INSTRUMENT	4291B、4339B
PRODUCT	COMMON MODE CHOKE	TEST FREQUENCY	100 MHz / 0.5V

PACKING DIMENSIONS (mm)

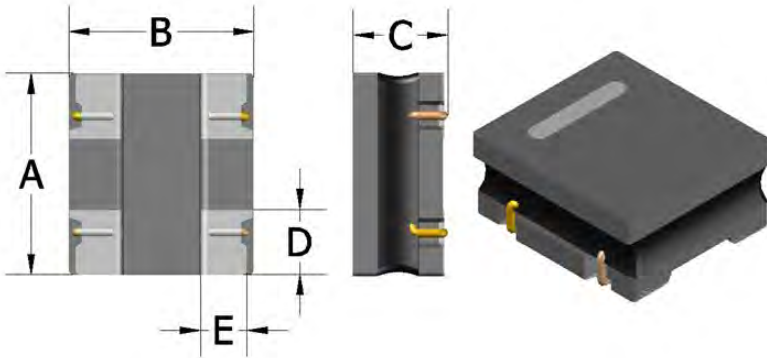

DB54A	Dimensions
A	5.0 ± 0.3
B	4.5 ± 0.3
C	2.5 Max.
D	1.6 ± 0.3
E	1.4 ± 0.3

EXPLANATION OF PART NUMBERS

DB	54A	-	102	S	-	PF
(1)	(2)		(3)	(4)		(5)

- (1) Product name
 (2) Shapes and dimensions
 (3) Impedance 【 at 100MHz 】

102:1000Ω

- (4) Tolerance

S = ±25% ; M = ±20%

· Equivalent Circuits

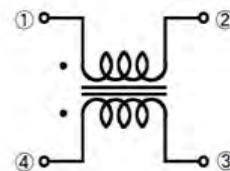

ELECTRICAL CHARACTERISTICS

P/N	Z(Ω)		Rated current	DCR (Ω)	Rated Voltage	Withstand Voltage	Insulation Resistance
	Point1-Point2	point3-point4					
	Impedance		Idc(A)	±40%	Vdc	Vdc	IR
	at 100MHz		[Max]		(V)Typical	(V)Typical	(MΩ)Min.
DB54A-101S-PF	100 Typ.		6	0.009	50	125	10
DB54A-251S-PF	250 Typ.		5	0.014			
DB54A-501S-PF	500 Typ.		4	0.019			
DB54A-102S-PF	1000 Typ.		3	0.024			
DB54A-142S-PF	1400 Typ.		1.5	0.040			

Operating temperature : -40 to +85°C

Storage temp. and humidity : -40 to +85°C ,70%RH max

Typical Heat Rating DC Current would cause an approximately ΔT of 40°C

If Use Wave soldering is there will be some risk. Re-flow soldering temperatures below 240 degrees, there will be unwitting risk

Solder standard according to IPC-A-610D 8.2.1 Chip Components - Bottom Only Terminations

CHARACTERISTICS

ITEM P/N	DB54A-SERIES-PF	TEST INSTRUMENT	4291B、4339B
PRODUCT	COMMON MODE CHOKE	TEST FREQUENCY	100 MHz / 0.5V

PERFORMANCE CURVES

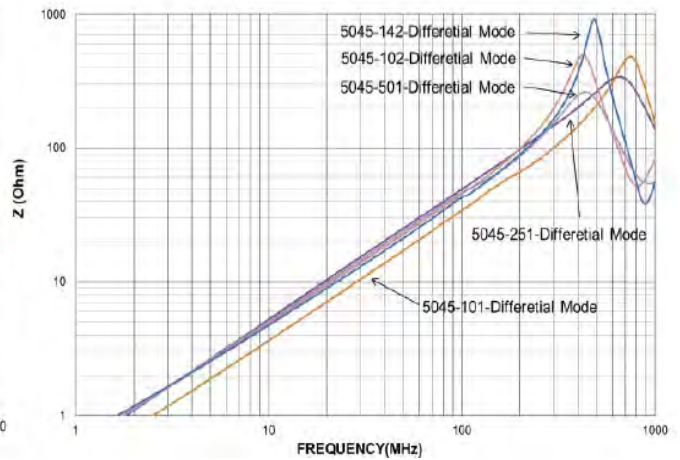
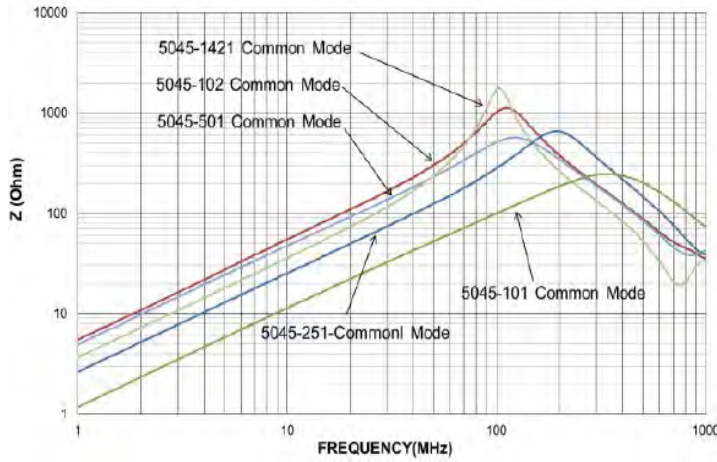

Recommended Footprint(mm)

54A	Dimensions
L	5.5 ref.
H	4.6 ref.
G1	2.35 ref.
G2	1.85 ref.

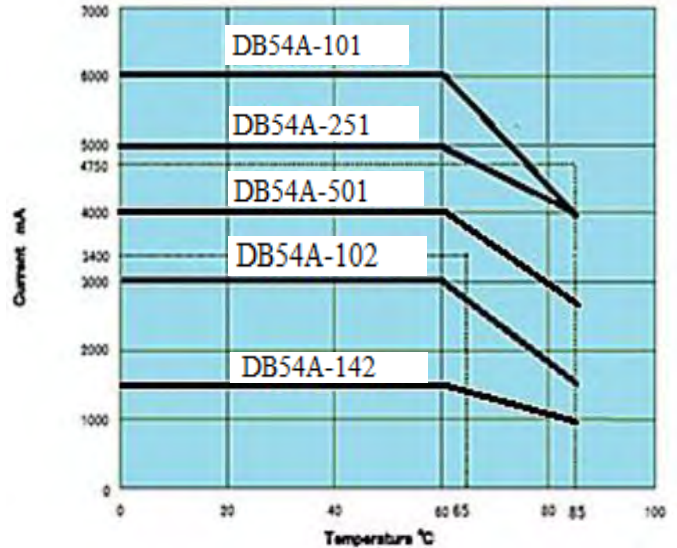
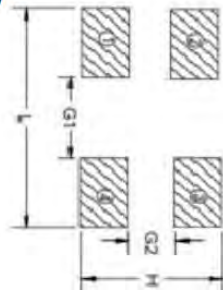

Electrical Performance

No.	Item	Specifications	Test Method
1	Impedance (Z) (at 10MHz)	Meet item 3.	Measuring Equipment : 4191A or the equivalents. Measuring Frequency : 10MHz
2	Insulation Resistance (I.R.)		Measuring Equipment ; R8340A or the equivalents. Test Voltage : 2times for Rated Voltage Time : within 60 s
3	DC Resistance (Rdc)		Measuring Current : 100 mA max. (In case of doubt in the above mentioned standard condition,measure by 4 terminal method.)
4	Withstanding Voltage	Products shall not be damaged.	Voltage : 125 V(DC) Time : 60 s Charge Current : 1 mA max.

CHARACTERISTICS

ITEM P/N	DB54A-SERIES-PF	TEST INSTRUMENT	4291B、4339B
PRODUCT	COMMON MODE CHOKE	TEST FREQUENCY	100 MHz / 0.5V

Mechanical Performance

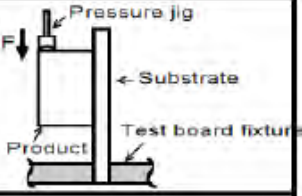
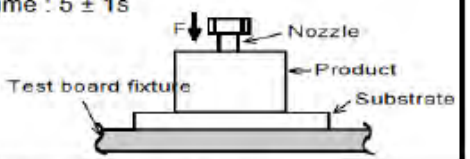
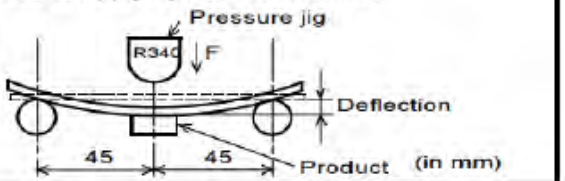
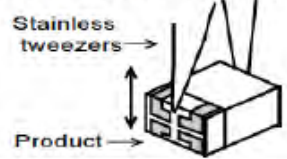
No.	Item	Specifications	Test Method								
1	Appearance and Dimensions		Visual Inspection and measured with Slide Calipers.								
2	Bonding Strength and Core Strength	No evidence of chipping, breakage. No evidence of coming off glass-epoxy substrate.	Applying Force (F) : 10N Applying Time : 5 ± 1s 								
3	Body strength	No evidence of chipping, breakage.	Applying Force (F) : 10N Applying Time : 5 ± 1s 								
4	Bending Strength	Meet Table 1. <u>Table 1</u> <table border="1" data-bbox="454 907 845 1131"> <tr> <td>Appearance</td> <td>No damaged.</td> </tr> <tr> <td>Impedance change (at 10MHz)</td> <td>within ± 20%</td> </tr> <tr> <td>I.R.</td> <td>10MΩ min.</td> </tr> <tr> <td>Withstanding Voltage</td> <td>No damaged.</td> </tr> </table>	Appearance	No damaged.	Impedance change (at 10MHz)	within ± 20%	I.R.	10MΩ min.	Withstanding Voltage	No damaged.	Substrate : Glass-epoxy (t=1.6mm) Deflection : 2.0mm Keeping Time : 30 s Speed of Applying Force : 0.5 mm/s 
Appearance	No damaged.										
Impedance change (at 10MHz)	within ± 20%										
I.R.	10MΩ min.										
Withstanding Voltage	No damaged.										
5	Vibration		Products shall be soldered on the substrate. Oscillation Frequency : 10 to 55 to 10Hz for 1 min. Total Amplitude : 1.5mm Testing Time : A period of 2 hours in each of 3 mutually perpendicular directions (Total 6 hours).								
6	Drop		Products shall be dropped concrete or steel board. Method : free fall Height : 1m The Number of Times : 10 Times								
7	Solderability	The electrodes shall be at least 90% covered with new solder coating.	Flux : Ethanol solution of rosin, 25(wt)% Pre heating : 150 ± 10°C, 1 minute. Solder : (1) Sn/Pb = 60/40 (2) Sn-3.0Ag-0.5Cu Solder Temperature : (1) 230 ± 5°C (2) 245 ± 5°C Immersion Time : 4 ± 1s Immersion and Immersion rates : 25mm/s 								
8	Resistance to Soldering heat	Meet Table 1.	Flux : Ethanol solution of rosin, 25(wt)% Pre heating : 150 ± 10°C, 1 minute. Solder : Sn/Pb = 60/40 or Sn-3.0Ag-0.5Cu Solder Temperature : 270 ± 5°C Immersion Time : 5 ± 1s Immersion and Immersion rates : 25mm/s Then measured after exposure in the room condition for 4 to 48 hours.								

RELIABILITY

ITEM P/N	DB54A-SERIES-PF	TEST INSTRUMENT	4291B、4339B
PRODUCT	COMMON MODE CHOKE	TEST FREQUENCY	100 MHz / 0.5V

Environmental Performance

(Product shall be soldered on the glass-epoxy substrate (t=1.6mm))

No.	Item	Specifications	Test Method
1	Temperature Cycle	Meet Table 1.	1 cycle 1 step : -25 °C (+0, -3)°C / 30min (+ 3, - 0) min 2 step : Ordinary temp. / 3 min max. 3 step : +85 °C (+3, -0)°C / 30min (+ 3, - 0) min 4 step : Ordinary temp. / 3 min max. Total of 10 cycles Then measured after exposure in the room condition for 4 to 48 hours.
2	Humidity		Temperature : 40 ± 2 °C Humidity : 90 to 95 %(RH) Time : 1000 h (+48 h , -0 h) Then measured after exposure in the room condition for 4 to 48 hours.
3	Humidity Load		Temperature : 40 ± 2 °C Humidity : 90 to 95 %(RH) Test Voltage : Rated Voltage Time : 1000 h (+48 h , -0 h) Then measured after exposure in the room condition for 4 to 48 hours. (ref. Item)
4	Heat life		Temperature : 85 ± 2 °C Test Voltage : 2times for Rated Voltage Time : 1000 h (+48 h , -0 h) Then measured after exposure in the room condition for 4 to 48 hours. (ref. Item)
5	Cold Resistance		Temperature : - 40 ± 2 °C Time : 1000 h (+48 h , -0 h) Then measured after exposure in the room condition for 4 to 48 hours. (ref. Item)

Terminal to be Tested

When measuring and supplying the voltage, the following terminal is applied.

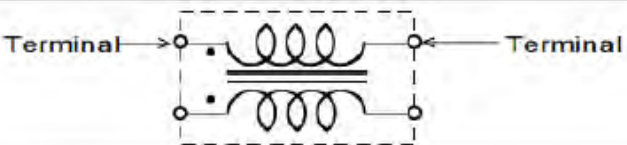
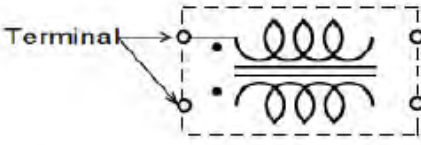
No.	Item	Terminal to be Tested
1	Impedance (Z) (Measurement Terminal)	
2	DC Resistance (Rdc) (Measurement Terminal)	
3	Insulation Resistance (I.R.) (Measurement Terminal)	
4	Withstanding Voltage (Measurement Terminal)	
5	Humidity Load (Supply Terminal)	
6	Heat Life (Supply Terminal)	

RELIABILITY

ITEM P/N	DB54A-SERIES-PF	TEST INSTRUMENT	4291B、4339B
PRODUCT	COMMON MODE CHOKE	TEST FREQUENCY	100 MHz / 0.5V

Soldering and Mounting

1. Soldering

Mildly activated rosin fluxes are preferred terminations are suitable for all wave and re-flow soldering systems. If hand soldering cannot be avoided, the preferred technique is the utilization of hot air soldering tools.

1.1 Solder re-flow:

Recommended temperature profiles for re-flow soldering in Figure 1.

1.2 Soldering Iron(Figure 2):

Products attachment with a soldering iron is discouraged due to the inherent process control limitations. In the case that a soldering iron must be employed, the following precautions are recommended.

- Preheat circuit and products to 150℃
- Never contact the ceramic with the iron tip
- Use a 20 watt soldering iron with tip diameter of 1.0mm
- 355℃ tip temperature (max)
- 1.0mm tip diameter (max)
- Limit soldering time to 4~5 sec.

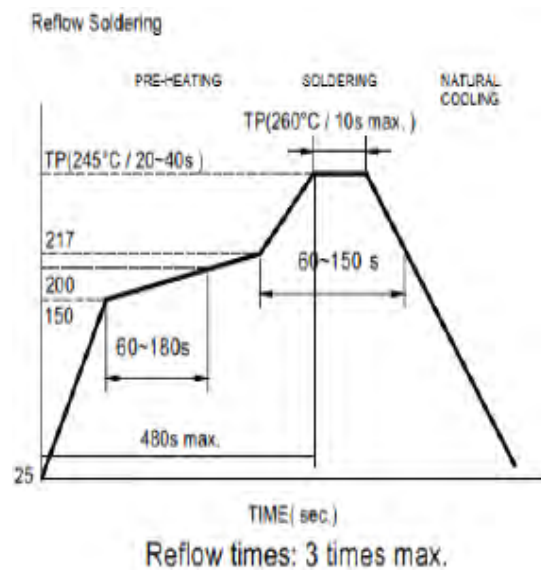

Fig.1

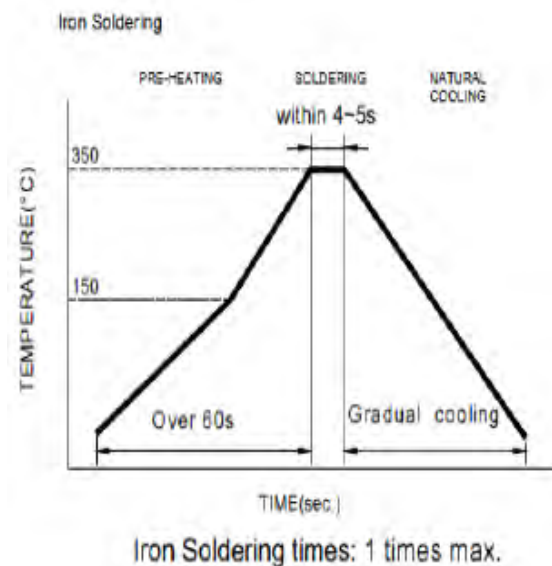

Fig.2

Version: 1.0

PACKING FOR SMD

ITEM P/N	DB54A-SERIES-PF	TEST INSTRUMENT	4291B、4339B
PRODUCT	COMMON MODE CHOKE	TEST FREQUENCY	100 MHz / 0.5V

Reel Dimension & Tape Dimension

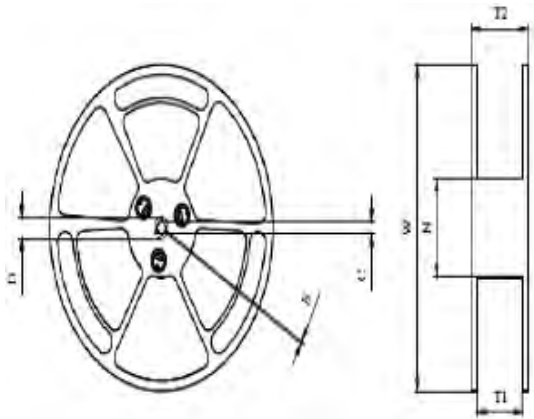

Type	W(mm)	D(mm)	C(mm)	T1(mm)	N(mm)	T2(mm)	E(mm)
φ 330	330±1.5	21.5+0.5/-0	13+0.5-0.2	2.5+0.5/-0	100±1.5	18.9±0.4	2.00±0.5

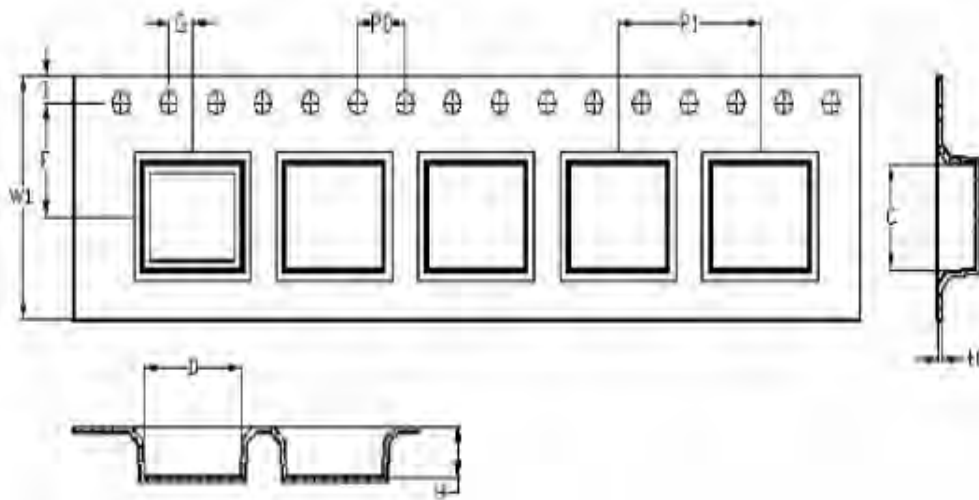

Series	size	W1(mm)	l(mm)	F(mm)	P0(mm)	G(mm)	P1(mm)	C(mm)	t0(mm)	D(mm)	H(mm)
DB54A	5045	12.00±0.3	1.75±0.1	5.50±0.1	4.00±0.1	2.00±0.1	8.00±0.1	4.9±0.1	0.35±0.05	5.10±0.1	2.70±0.1

PACKING FOR SMD

ITEM P/N	DB54A-SERIES-PF	TEST INSTRUMENT	4291B、4339B
PRODUCT	COMMON MODE CHOKE	TEST FREQUENCY	100 MHz / 0.5V

Packaging Information

Chip size	Chip/Reel
DB54A	2500

Tearing Off Force

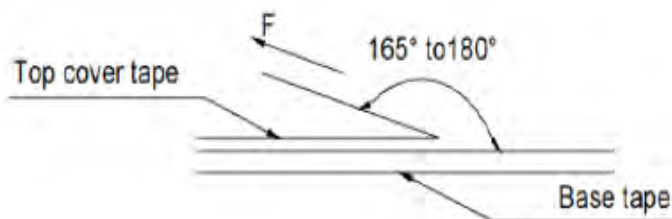

The force for tearing off cover tape is 15 to 80 grams in the arrow direction under the following conditions.

Room Temp. (°C)	Room Humidity (%)	Room atm (hPa)	Tearing Speed mm/min
5~35	45~85	860~1060	300

Application Notice

• Storage Conditions

To maintain the solderability of terminal electrodes:

1. products meet IPC/JEDEC J-STD-020D standard-MSL, level 1.
2. Temperature and humidity conditions: Less than 40°C and 60% RH.
3. Recommended products should be used within 12 months form the time of delivery.
4. The packaging material should be kept where no chlorine or sulfur exists in the air.

• Transportation

1. Products should be handled with care to avoid damage or contamination from perspiration and skin oils.
2. The use of tweezers or vacuum pick up is strongly recommended for individual components.
3. Bulk handling should ensure that abrasion and mechanical shock are minimized.